

General EMI Filter with High Attenuation Performance

Feature and Benefits

- BL 2030 Single-stage filters are designed for easy and fast chassis mounting.
- The BL2030 filters are also available as B versions with no Y-capacitors for medical applications as well as A versions with low capacitance for safety critical applications with a requirement for low leakage currents.
- All filters provide an exceptional conducted attenuation performance, based on chokes with high permeable core material and excellent thermal behavior
- BL 2030 Single-stage filters are designed for noisy applications requiring excellent filter performance
- BL 2030 filters are also available as dual stage filters (BL2090 series)
- Various terminal options allow you to select the desired connection style
- Rated current from 1 to 30 A
- Very high differential and common mode Attenuation
- Optional medical version (Type B)
- Optional safety version (Type A)



Technical specifications

Maximum continuous operating voltage	250VAC, 50/60Hz
Operating Frequency	DC to 400Hz
Rated Currents	1 to 30A @40°C
High Potential Test voltage	L-GND 2550 VDC for 2 sec L-GND 3500 VDC for 2 sec (B types) L - N 1100 VDC for 2 sec
Temperature range (operation and storage)	-25°C to +100°C (25/100/21)
Certified to	UL 1283,EC/EN60939 (Applies to AC and DC Applications)
Flammability Corresponding to	UL 94V-2 better

ELECTRICAL SCHEMATIC

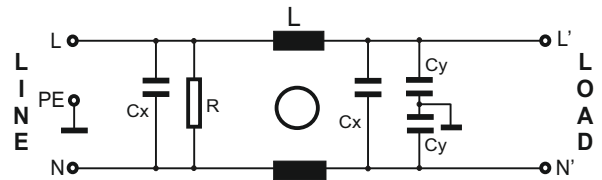

Type B (Medical Version)

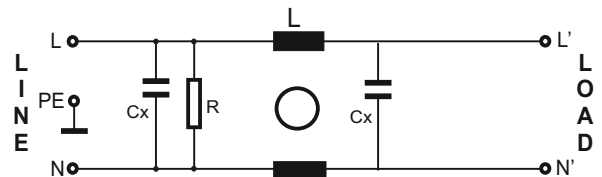

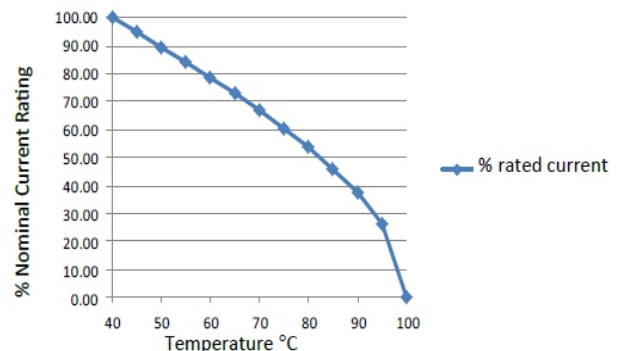

Temperature Derating Curve for EMC Filters Rated at 40°C Ambient and 100°C Maximum



Typical Application

- Electrical and electronic equipment
- Consumer goods
- EV Application
- Medical equipment
- Electronic data processing equipment
- Very Noisy Application high performance Filter
- Motor drive and VFD, Automation

FILTER SELECTION TABLE

Filters**	Rated current @40°C A	Leakage current @250V/50Hz mA	Inductance (L-L) ΣL mH	Capacitance (L-N) ΣCx μF	Capacitance (L-G) ΣCy nF	Resistance (L-N) ΣR K Ω	Connexion type			Weight gram (g)
										
BL2030-1-X	1(1.15)	0.34	20	0.44	4.4	1000	F	W		60
BL2030-3-X	3(3.45)	0.52	14	0.66	6.6	1000	F	W		85
BL2030-4-X	4(4.50)	0.52	14	0.66	6.6	1000	F	W		90
BL2030-6-X	6(6.90)	0.73	8	0.94	9.4	680	F	W		100
BL2030-8-X	8(8.90)	0.73	8	0.94	9.4	680	F	W		170
BL2030-10-X	10(11.5)	0.73	8	0.94	9.4	680	F	W		200
BL2030-12-X	12(13.8)	0.87	4	2.00	20	330	F	W		185
BL2030-16-X	16(18.4)	0.87	4	2.00	20	330	F	W		220
BL2030-20-X	20(23.0)	0.87	4	2.00	20	330	F	W	S	290
BL2030-30-S	30(34.5)	0.87	2	2.00	20	330			S	330
Low Leakage Version										
BL2030A-1-X	1(1.15)	0.074	20	0.44	0.94	1000	F	W		60
BL2030A-3-X	3(3.45)	0.074	14	0.66	0.94	1000	F	W		85
BL2030A-4-X	4(4.50)	0.074	14	0.66	0.94	1000	F	W		90
BL2030A-6-X	6(6.90)	0.074	8	0.94	0.94	680	F	W		100
BL2030A-8-X	8(8.90)	0.074	8	0.94	0.94	680	F	W		170
BL2030A-10-X	10(11.5)	0.074	8	0.94	0.94	680	F	W		200
BL2030A-12-X	12(13.8)	0.074	4	2.00	0.94	330	F	W		185
BL2030A-16-X	16(18.4)	0.074	4	2.00	0.94	330	F	W		220
BL2030A-20-X	20(23.0)	0.074	4	2.00	0.94	330	F	W	S	290
BL2030A-30-S	30(34.5)	0.074	2	2.00	0.94	330			S	330
Medical Version Without Y cap										
BL2030B-1-X	1(1.15)	0.002	20	0.44		1000	F	W		60
BL2030B-3-X	3(3.45)	0.002	14	0.66		1000	F	W		85
BL2030B-4-X	4(4.50)	0.002	8	0.66		1000	F	W		90
BL2030B-6-X	6(6.90)	0.002	8	0.94		680	F	W		100
BL2030B-8-X	8(8.90)	0.002	8	0.94		680	F	W		170
BL2030B-10-X	10(11.5)	0.002	8	0.94		680	F	W		200
BL2030B-12-x	13(00.0)	0.002	4	2.00		330	F	W		185
BL2030B-16-X	16(18.4)	0.002	4	2.00		330	F	W		220
BL2030B-20-X	20(23.0)	0.002	4	2.00		330	F	W	S	290
BL2030B-30-S	30(34.5)	0.002	2	2.00		330			S	330

To compile a complete part number, please replace the -.. with the required I/O connection style (e.g. BL 2030-20-S, BL 2030B-6-F). The different letters code the
 ** Maximum leakage under usual AC operating conditions (acc. IEC 60939-3). Note: if the neutral line is interrupted, worst case leakage could reach twice this level.

TYPICAL INSERTION LOSS, dB (50/50 Ohm)

Insertion Loss: Common mode - —
 Differential mode- —

1 to 6 A

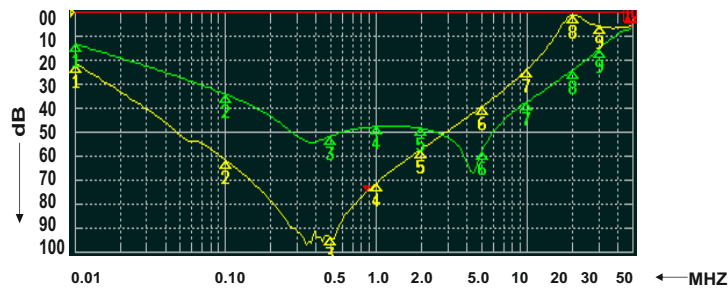

8 to 12 A

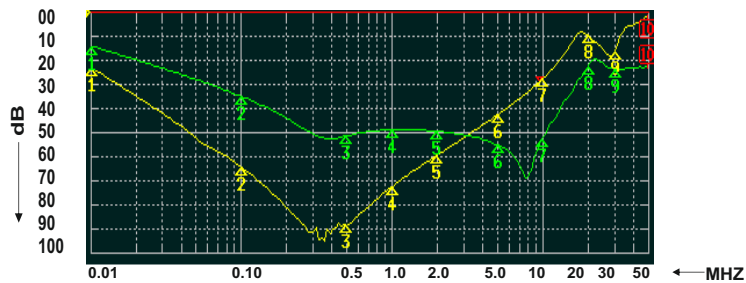

16 to 20 A

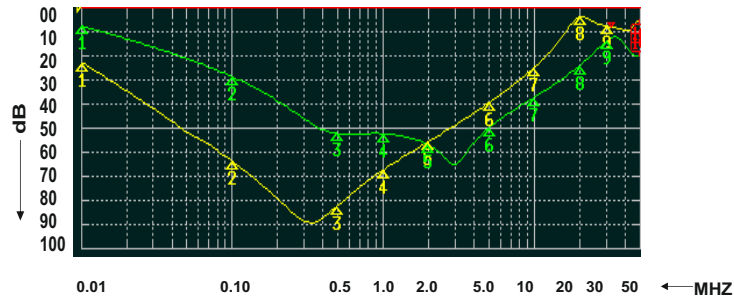

30 A

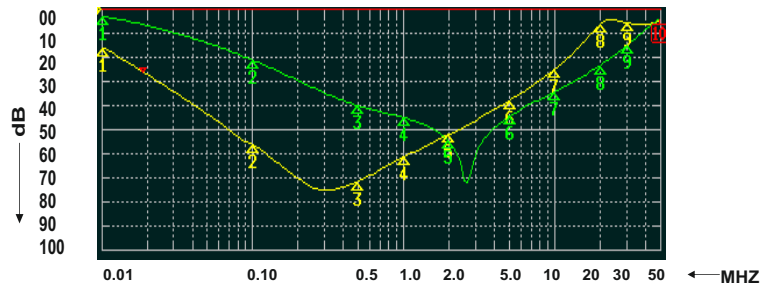

MECHANICAL DETAILS

1Amp

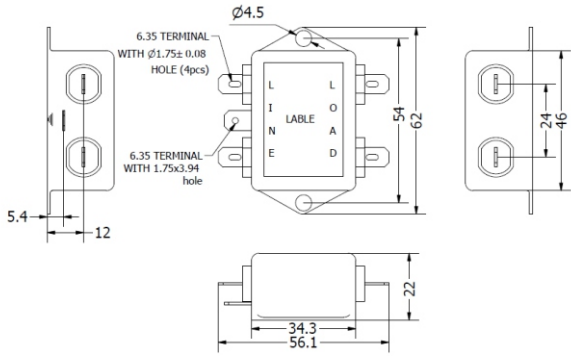

8,10 & 12 Amp Faston Terminal

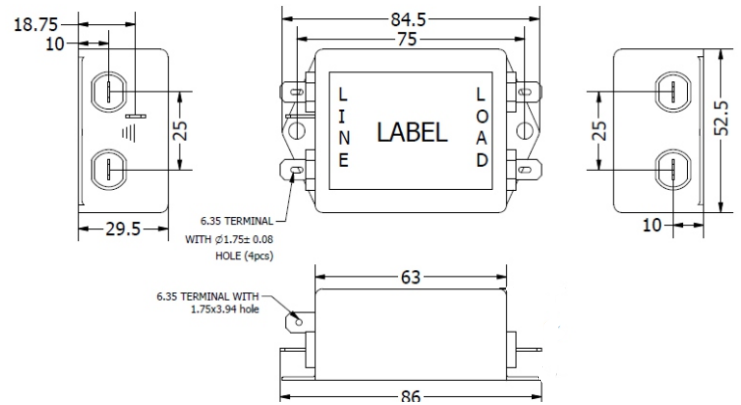

3,4 & 6 Amp Faston Terminal

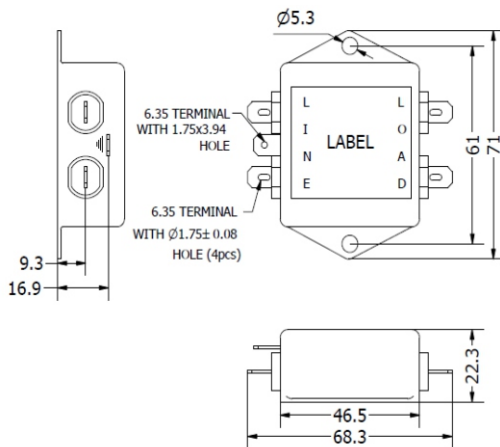

16 & 20 Amp Faston Terminal

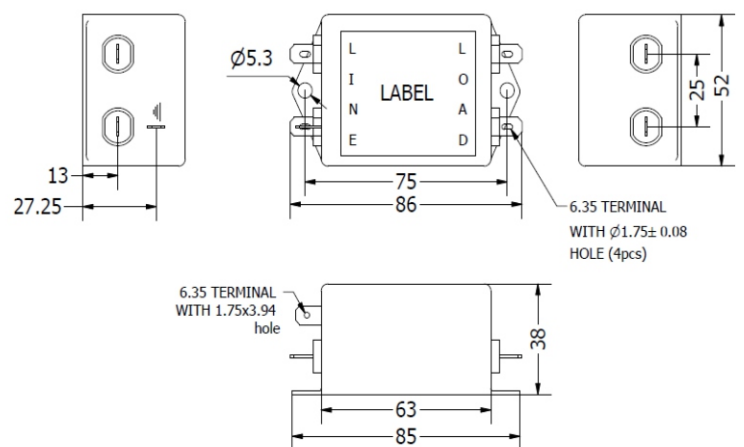

20 & 30 Amp Screw Terminal (M4)

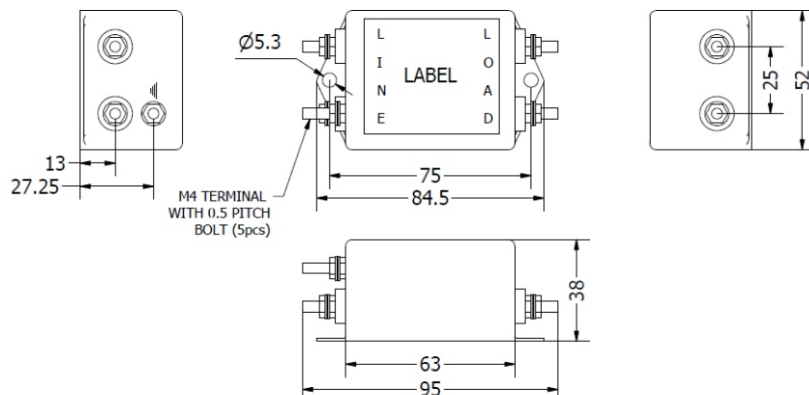

**All Dimension are in mm